

Viraj Daisy Mini Direct Pendant

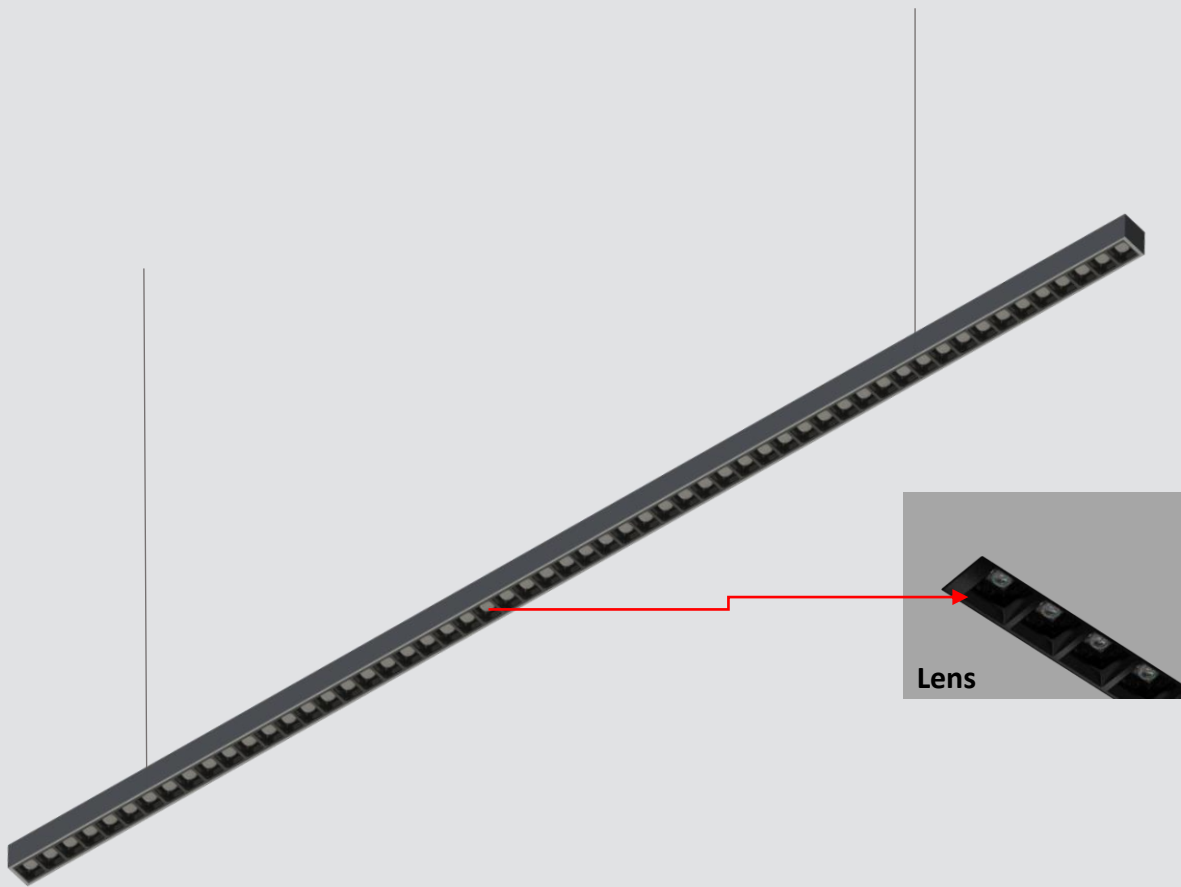

Model no : DL-TVD-MINIDPL-25

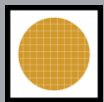

Low-power LEDs



5700k

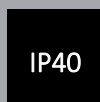

IP40



Excellent thermal management

MACADAM 3



Direct

Structure and Characteristics

The features described here are typical of products in this range. Special versions may offer additional or varying features

1 - Optics

Lens

2 - LED Module

25W

3 - Luminaire head and housing

Aluminium extrusion

4 - Control Gear

NON-Dimmable/Dali-Dimmable

5 - Protection Mode

IP40

6 - CCT

5700k

Dimensions

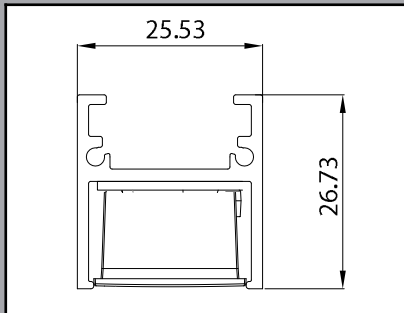

Dimensions

L=1200mm
W=25.5mm
H=26.7mm

Efficacy

115 lm/W

CRI

≥80

Mounting

Pendant

Life Span

L70 (60,000H)

UGR

<19

Beam angle

60°

Dimming

NON-Dimmable/
Dali-Dimmable

Housing Finish

Powder coated

Led Module

25W

CCT

5700k

Input Voltage

220-240 Vac

Power Factor (PF)

0.95

McAdam

3rd

THD

<10%

